





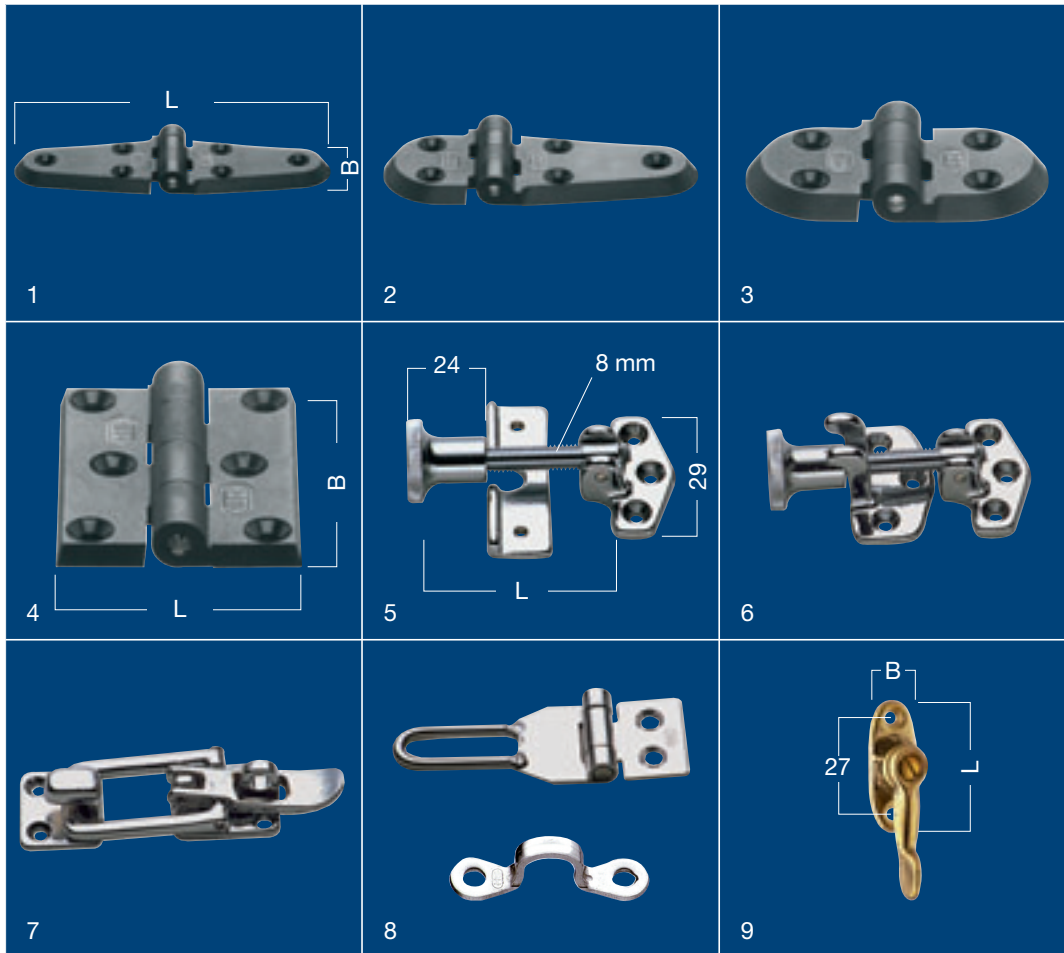

		L mm	B mm	 mm	boring for	art.-no.	
1	strap hinge 6 holes stainless steel		80	30	1,5	counter sunk screw 5 mm	33510 000 55
2	strap hinge 4 holes stainless steel		50	30	1,5	counter sunk screw 5 mm	33510 001 55
3	strap hinge 5 holes stainless steel		65	30	1,5	counter sunk screw 5 mm	33510 002 55
4	strap hinge 6 holes stainless steel		110	30	1,5	counter sunk screw 5 mm	33510 003 55
5	strap hinge 6 holes stainless steel		100	40	2,0	counter sunk screw 5 mm	33515 100 55
6	strap hinge 6 holes stainless steel		150 200 250	40 40 40	2,0 2,0 2,0	counter sunk screw 5 mm	33515 150 55 200 55 250 55
7	strap hinge 4 holes AISI 316 stainless steel		103	27	4,5	counter sunk screw 5 mm	33540 000 56
8	strap hinge 6 holes AISI 316 stainless steel		98	37	4,5	counter sunk screw 5 mm	33541 000 56



		L mm	B mm	art.-no.
1	plastic strap hinge black plastic, high impact, heat- and cold resistant bolt of stainless steel, holes for 5mm counter sunk screws	140	40	33520 001 63
2	plastic strap hinge black plastic, high impact, heat- and cold resistant bolt of stainless steel, holes for 5mm counter sunk screws	110	40	33520 002 63
3	plastic strap hinge black plastic, high impact, heat- and cold resistant bolt of stainless steel, holes for 5mm counter sunk screws	75	40	33520 003 63
4	plastic strap hinge black plastic, high impact, heat- and cold resistant bolt of stainless steel, holes for 5mm counter sunk screws	50	65	33521 003 63
5	fastener with counter plate brass chrome plated	60 105		33355 000 32 33357 000 32
6	fastener with counter plate brass chrome plated	60 105		33358 000 32 33359 000 32
7	hatch fastener brass chrome plated with 6 mm boring for lock			33335 000 32
8	overfall stainless steel fender cleat stainless steel	90	30	33345 000 55 37921 016 55
9	sash fastener brass polished	38	16	33450 000 33